

## **Disturbance of stratification caused by direct horizontal inlets into a water storage tank**

**Michel Y. Haller<sup>1</sup>, Igor Mojic<sup>1</sup>, Elimar Frank<sup>1</sup>, Matthias Kaufmann<sup>1</sup>, Lukas Lötscher<sup>2</sup>, Jason Podhradsky<sup>2</sup>, Andreas Huggenberger<sup>2</sup>, Simon Boller<sup>3</sup> and Boris Meier<sup>3</sup>**

<sup>1</sup> Institut für Solartechnik SPF, Hochschule für Technik HSR, Oberseestr. 10, 8640 Rapperswil

<sup>2</sup> Studiengang Erneuerbare Energien und Umwelttechnik, Hochschule für Technik HSR, Oberseestr. 10, 8640 Rapperswil

<sup>3</sup> Institut für Energietechnik IET, Hochschule für Technik HSR, Oberseestr. 10, 8640 Rapperswil

### **Abstract**

Water based combi-storages are frequently used in Central Europe for storing heat for space heating and domestic hot water in one device. The stratification efficiency of direct combi-storage inlets has a decisive influence on the energetic efficiency of solar thermal systems and even more of heat pumps that are connected to combi-storages. However, there are currently no simple recommendations for the geometrical design of direct storage inlets together with scientifically supported values for maximum mass flow rates that can be used for charging without disturbing stratification in the storage. In this work, the effect of different geometrical designs and mass flow rates on stratification of the storage was studied for direct storage inlets with computational fluid dynamics. Selected experiments were validated with laboratory tests.

key words: combi-storage, stratification, heat pump, solar thermal, computational fluid dynamics.

---

### **1. Introduction**

Water storage devices are used in almost all residential buildings for storing domestic hot water (DHW). With increasing use of solar thermal heating, heat pumps, pellet heating, and photovoltaic self-consumption, also the use of storages for space heat is expected to increase. Combi-storage that can store heat for both DHW and space heating in one device have the advantage of being more economic (more compact and only one unit to be installed), as well as more energy efficient (less heat losses), than a two storage solution. However, the efficiency of solar thermal systems as well as of heat pumps decreases significantly if stratification of the combi-storage is poor (Sharp & Loehrke 1979; Phillips & Dave 1982; Haller et al. 2014).

Computational fluid dynamics (CFD) has been used already in the past to investigate the effect of geometry and mass flow rates for direct inlets that are placed at the bottom or at the top of a storage tank (Shah & Furbo 2003; Aviv et al. 2009; van Berkel et al. 2002). However, only few studies were dealing with the inlet that is usually placed at about half the height of an 800 liter combi-storage and that is used by an auxiliary heater (e.g. a heat pump) for charging the space heating zone of the storage. This inlet at mid-height is of particular importance for the stratification efficiency of solar and heat pump systems. If charging the storage space heat zone by this inlet disturbs the zone above that is reserved for DHW, the heat pump switches to DHW charging more frequently than necessary, and is thus providing heat at higher temperatures than required. This leads to a significant decrease of the systems exergetic and energetic efficiency – as shown by Haller et al. (2014) and Haberl et al. 2014. A rare example of CFD simulations and laboratory experiments for the inlet at mid height of a combi-storage was published by Drück (2007) for water inlet velocities from 0.2 to 2.0 m/s. The stratification was much better with lower mass flow rates. The disturbance of an already existing hotter DHW section above the inlet or general recommendations for maximum inlet velocities that do not cause such a disturbance were not part of Drück's publication. For the given reasons, in the work presented here, CFD was used to simulate different mass flow rates and different geometries for the inlet at

mid-height of a combi-storage, and the effect on the temperatures of the DHW zone above are presented. Selected experiments have been validated with laboratory measurements.

## 2. Methods

### 2.1 General

For the simulations, ANSYS CFX (Workbench 14.0 and 14.5.7) has been used. 3D geometries have been designed in NX6 from Siemens.

The volume of the simulated cylindrical storage tank was 800 l. The initial state of the storage was 50 °C (for DHW) in the upper half of the storage and 30 °C (for space heating) in the lower half of the storage. The 2 inch inner diameter (2" i.d.) inlet was placed at the center of the storage height, and the inlet-temperature was constantly 30 °C. The outlet was placed half-way between the inlet and the bottom (Fig. 1). Based on the assumption of a system with an 8 kW heat pump operating with a delta-T of 5 K, the maximum mass flow rate was assumed to be 1800 kg/h. The simulation results were evaluated after one hour of simulated real time.

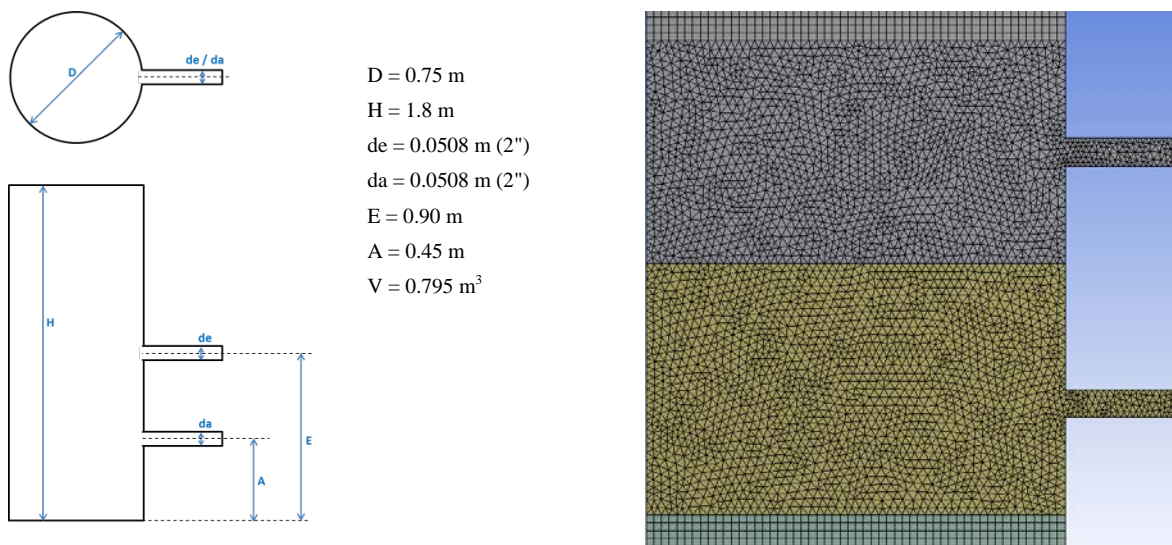

Fig. 1: Dimensions and meshing cutout of the simulated storage device (first set of simulations)

### 2.2 First set of simulations

A first set of simulations was performed in order to study both the effect of different mass flow rates at the middle port inlet as well as the influence of different inlet geometries.

A tetrahedron mesh has been used in the inlet and outlet region (height 0.25 to 1.1 m), whereas a hexahedral mesh has been used in the regions that are further away from the inlet (Fig. 1 right). A mesh size study revealed that results changed significantly when the mesh size was decreased from 20 mm to 15 mm in the inlet region, and from 40 mm to 30 mm in the other regions. A further decrease in mesh size showed only small differences in the temperature profiles after one hour of simulation. The shear stress transport (SST) model implemented in ANSYS CFX has been used with default settings.

Furthermore, for this study, the following simplifications were made in order to decrease the simulation time:

- the symmetry of the storage vessel was used and only half of the storage volume was simulated - a comparison with a simulation with the full storage volume revealed no visible differences in the results
- the storage wall was not simulated, only the water body with no-slip condition at its boundaries
- the boundaries of the water body have been assumed to be adiabatic, hence heat losses of the vessel are zero

The target of this study was not to reflect reality as closely as possible, but to study the influence of turbulences created by an inlet jet, if possible excluding the disturbances created by other effects. It is thus

assumed that for the purpose of showing the influence of mass flow rates and the influence of inlet geometry on storage stratification over one hour of operation, the simplifications listed above do not influence the results significantly.

### 2.3 Laboratory measurements and second set of simulations

Laboratory measurements have been performed using a 750 l storage tank as shown in Fig. 2b. The storage tank had an inspection opening at the backside for mounting and unmounting of inlet flow velocity mitigation and stratifier devices.

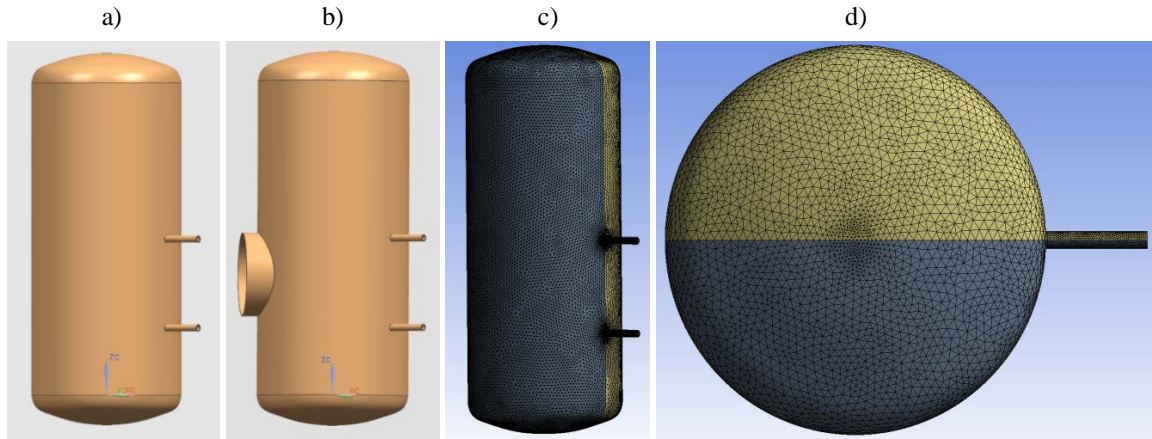

Fig. 2: The storage tank with (a) and without (b) inspection opening and its tetrahedron meshing in side view (c) and top view (d)

The piping and instrumentation diagram of the test rig and storage tank can be seen in Fig. 3. The sensors and their accuracy are listed in Table 1.

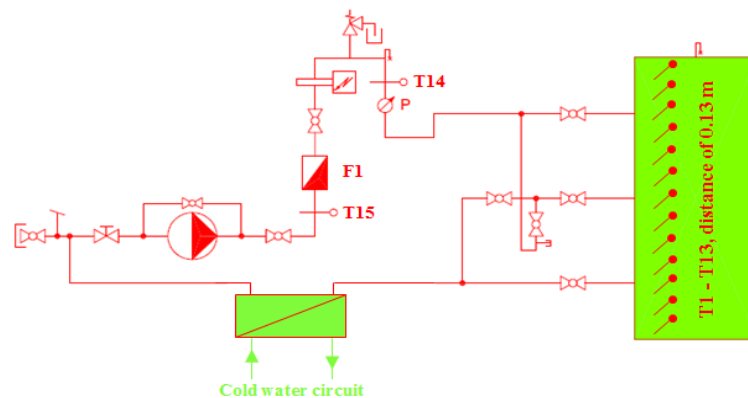

Fig. 3: Piping and instrumentation diagram (P&ID) of the test rig and storage tank

Table 1: Measurement devices and their accuracy

sensor	sensor type	Accuracy (in used range)
T1 – T13	immersed resistance thermometers PT100	+/- 0.1 K
T14 – T15	immersed resistance thermometers PT100	+/- 0.1 K
F1	electromagnetic flowmeter	+/- 0.5 %

The procedure for the measurement of the disturbance of the 50 °C DHW zone by inlet mass flow at the middle port was as follows:

1. emptying the storage tank, mounting or dismounting flow velocity mitigation devices or inlet pipes as required, and filling of the storage tank, while deaerating

2. heating the storage tank to 30 °C ( $\pm 1.5$  K)
3. waiting for 10 min
4. charging the storage tank through the top inlet with 50 °C inlet temperature, while discharging from the middle port, with 0.5 kg/s mass flow rate, for exactly one hour
5. waiting for 10 min
6. switching to conditioned inlet temperature of 30 °C at the middle port inlet with exit at 0.25 relative to the storage height, with a constant mass flow rate that differs from experiment to experiment
7. stop the mass flow rates after one hour of operation

CFD simulations were adapted to closer match the laboratory conditions. In particular, the following adaptations and pre-studies were performed:

- The geometry of the storage tank was adapted from a strict cylinder to the geometry with round top and bottom as shown in Fig. 2. The meshing had to be redone for this geometry and was redone with a mesh-size of 20 mm for the water body.
- The storage tank was simulated once without and once with the inspection hole included in the storage geometry, for the case of direct horizontal 2" inlet. The inspection hole was found to have no significant effect on the stratification after one hour of simulations with 0.5 and with 0.125 kg/s mass flow rate.
- The inlet diameter was changed from 2" (previous studies) to 1".
- The storage tank was simulated once with and once without heat conduction within the storage wall and heat losses through the storage wall. For simulations with storage wall, the wall-meshing was 10 mm, and the meshing of the water body was reduced gradually in the storage wall region in order to adapt to 10 mm. It was found that heat losses and the storage wall itself had no significant effect after one hour of simulation with forced mass flow through the storage.
- The storage tank was simulated once as a whole body and once as half of the volume (see different colors of the meshing in Fig. 2c+d), using the symmetry of the storage tank without inspection opening. There was no significant difference between the whole body simulation and the half-body simulation.

The final results that are compared with simulations in the results section of this paper have been performed with the whole body, with man inspection opening, and with the storage wall. The mass flow rates and temperatures used in the simulation were given as inputs through a text-file in order to reproduce exactly the conditions of the laboratory measurements.

### 3. Results

#### 3.1 Influence of mass flow rates and inlet geometries

Different inlet geometries were simulated with inlet mass flow rates of 450, 900, and 1800 kg/h. On the one hand, direct horizontal 2" (HOR 2") and 4" (HOR 4") inlets without any special measures for the mitigation of inlet flow velocities or turbulences were simulated. On the other hand, the more complex inlet geometries shown in Fig. 4 were also simulated. These simulations have been performed by Huggenberger (2013).

Fig. 5 shows the disturbance of the upper storage region after 1 hour of storage operation with inlet temperature of 30 °C at mid-height of the storage for the different mass flow rates. The resulting disturbance of the temperature stratification after one hour is clearly dependent on the mass flow rate on the one hand, and on the inlet geometry on the other hand. Mass flow rates of 450 kg/h correspond to inlet flow velocities of 0.064 m/s for the 2" i.d. (inner diameter) pipe. With this low inlet velocity, not much difference is found between the temperature profiles resulting from different inlet geometries. However, already with inlet mass flow rates of 900 kg/h (0.127 m/s) the 2" direct horizontal pipe inlet leads to a significant decrease in stratification. This decrease in stratification compared to the results obtained with lower mass flow rates is effectively prevented by a larger inlet diameter of 4" or by a long channel (PLATE-L) that increases the

hydraulic diameter of the pipe from 2" (50 mm) to 2-4A/P = 120 mm. In contrast to all other inlet geometries, PLATE-L does not show an increase in the disturbance of the stratification with increasing inlet mass flow rates up to 1800 kg/h. For this highest simulated mass flow rate, the average inlet flow velocity for PLATE-L is 0.07 m/s. Interestingly, a shorter channel of the same diameter or T pieces of shorter length do not prevent the disturbance of the upper zone as effectively as PLATE-L, although the average inlet velocity of T 2"-3" is only 0.06 m/s.

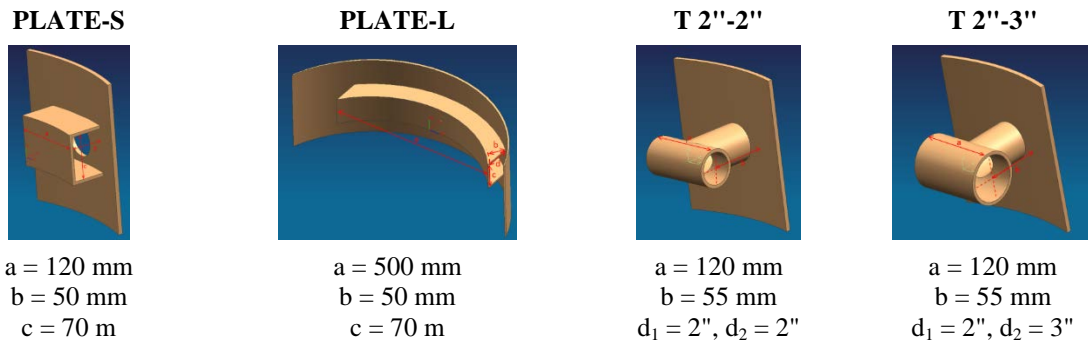

Fig. 4: Different inlet geometries and their dimensions

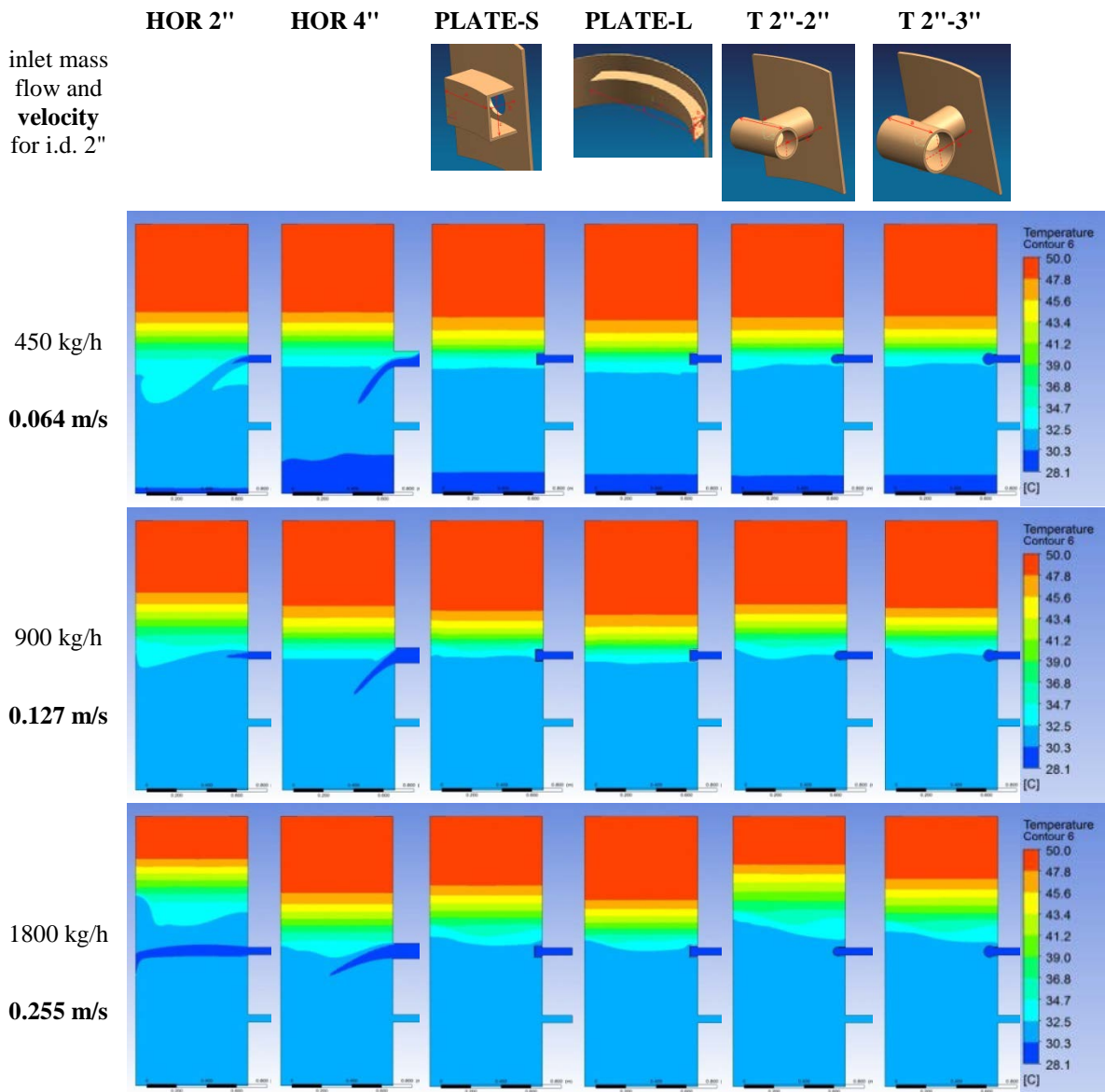

Fig. 5: CFD Simulations of an originally stratified storage (top 50 °C, bottom 30 °C) with inlet (ø 2", 30 °C) at mid-height of the storage; status after one hour of simulated operation with different mass flow rates and inlet geometries. The inlet flow velocities are given for the 2" inner diameter pipe

### 3.2 Influence of length of mitigation zone

Simulation results for PLATE-S and PLATE-L as well as the results for T 2"-3" showed clearly, that not only the hydraulic diameter or the average inlet velocity play an important role in the disturbance of the stratification, but apparently also the length of the flow velocity reduction zone that was quite longer for PLATE-L than for the other inlet geometries. For this reason, Kaufmann (2013) analyzed the influence of the length of the mitigation zone more in detail, by simulating a T-piece with different length of the double-hose as shown in Fig. 6.

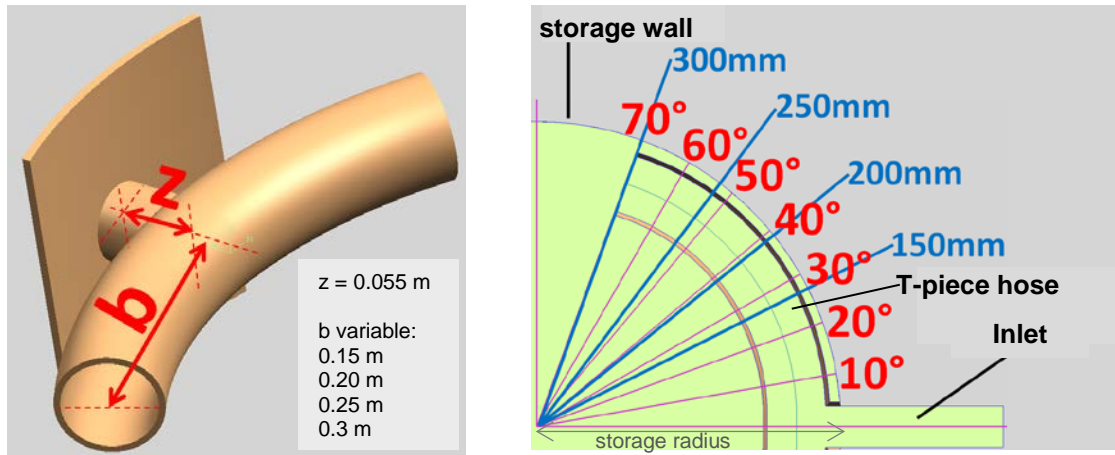

Fig. 6: T-piece 2"-3" with different lengths for the double hose and cross-section scheme for the evaluation of the flow velocity profile within the hose at different distances from the inlet spout (see Fig. 8)

An evaluation of the temperatures at different storage heights after one hour of simulation for T-piece inlets with different lengths of the double hose is shown in Fig. 7. It is clearly visible that an increase of the hose length from 0.15 m to 0.20 m reduces the disturbance of the upper hot zone, whereas a further increase of the length only has a marginal effect.

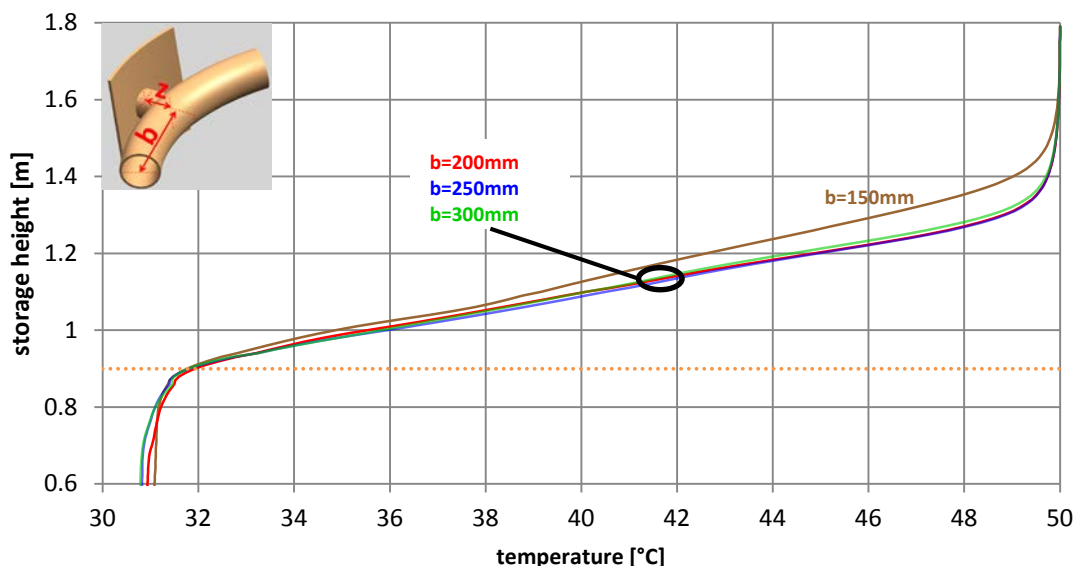

Fig. 7: Temperature curves across the storage height after one hour of simulation with mass flow rates of 1800 kg/h and different lengths  $b$  for the double hose of the T-piece

Fig. 8 shows that the velocity profile in the T-piece hose is not homogeneous and the flow not well developed for angles (see Fig. 6) that are below 40° (0.25 m hose length). However, already at 0.2 m hose length there was no further advantage in further increasing the hose length. The maximum velocity within the velocity profile at the outlet of the T-piece with 0.2 m hose length was around 0.12 m/s.

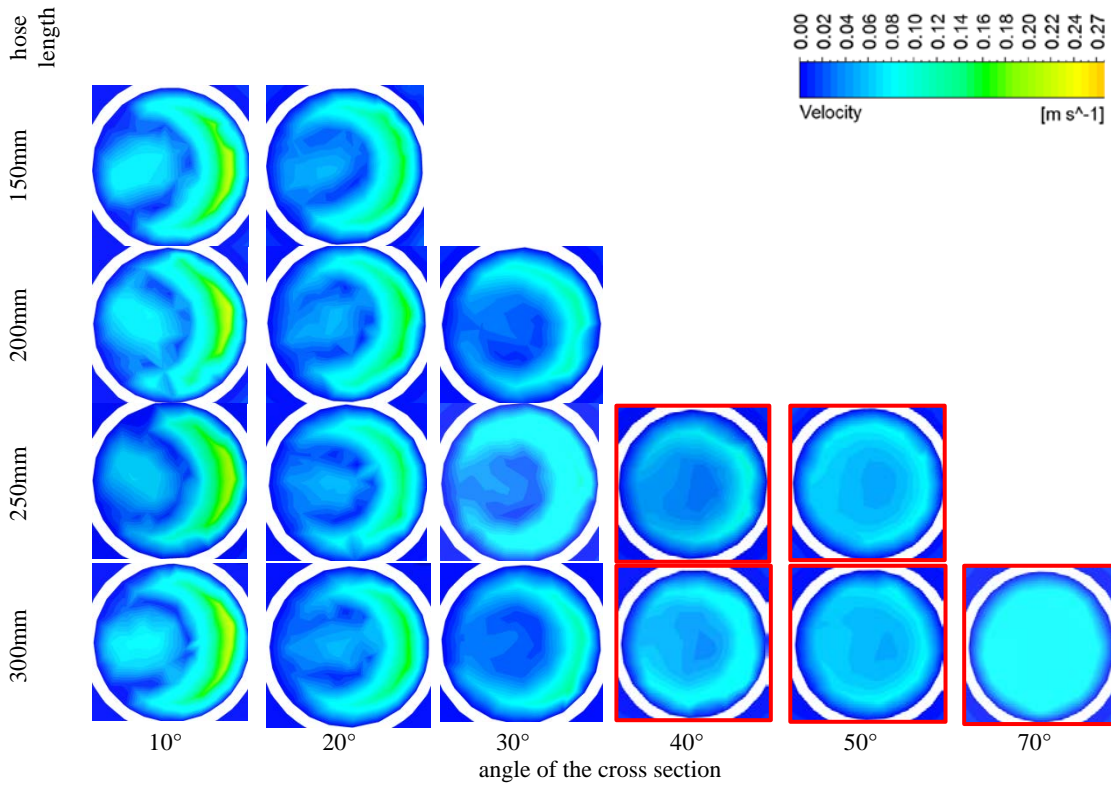

Fig. 8: Velocity profiles at different cross sections of the T-piece hose taken at different angles as (compare Fig. 6) for mass flow rates of 1800 kg/h

### 3.3 Validation with laboratory experiments

Laboratory experiments were performed with 1" i.d. pipe connections to the storage tank, with and without inlet flow velocity mitigation by means of the channel/plate device shown in Fig. 9a. All experiments were performed with inlet mass flow rates of 450, 900, and 1800 kg/h once with and once without a 90° elbow (Fig. 9b) before the storage tank inlet. Laboratory experiments as well as the simulation results shown in this section were performed and evaluated by Lötscher & Podhradsky (2014).

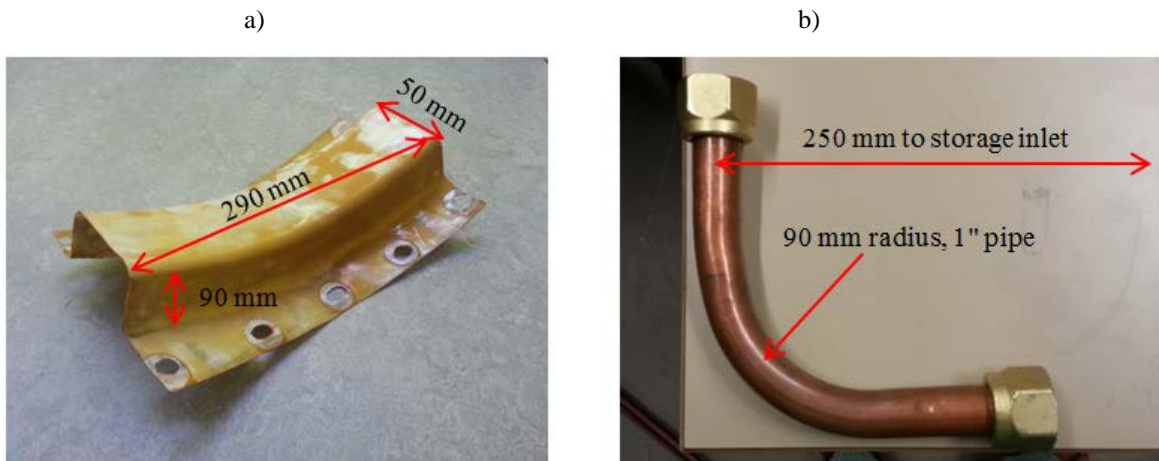
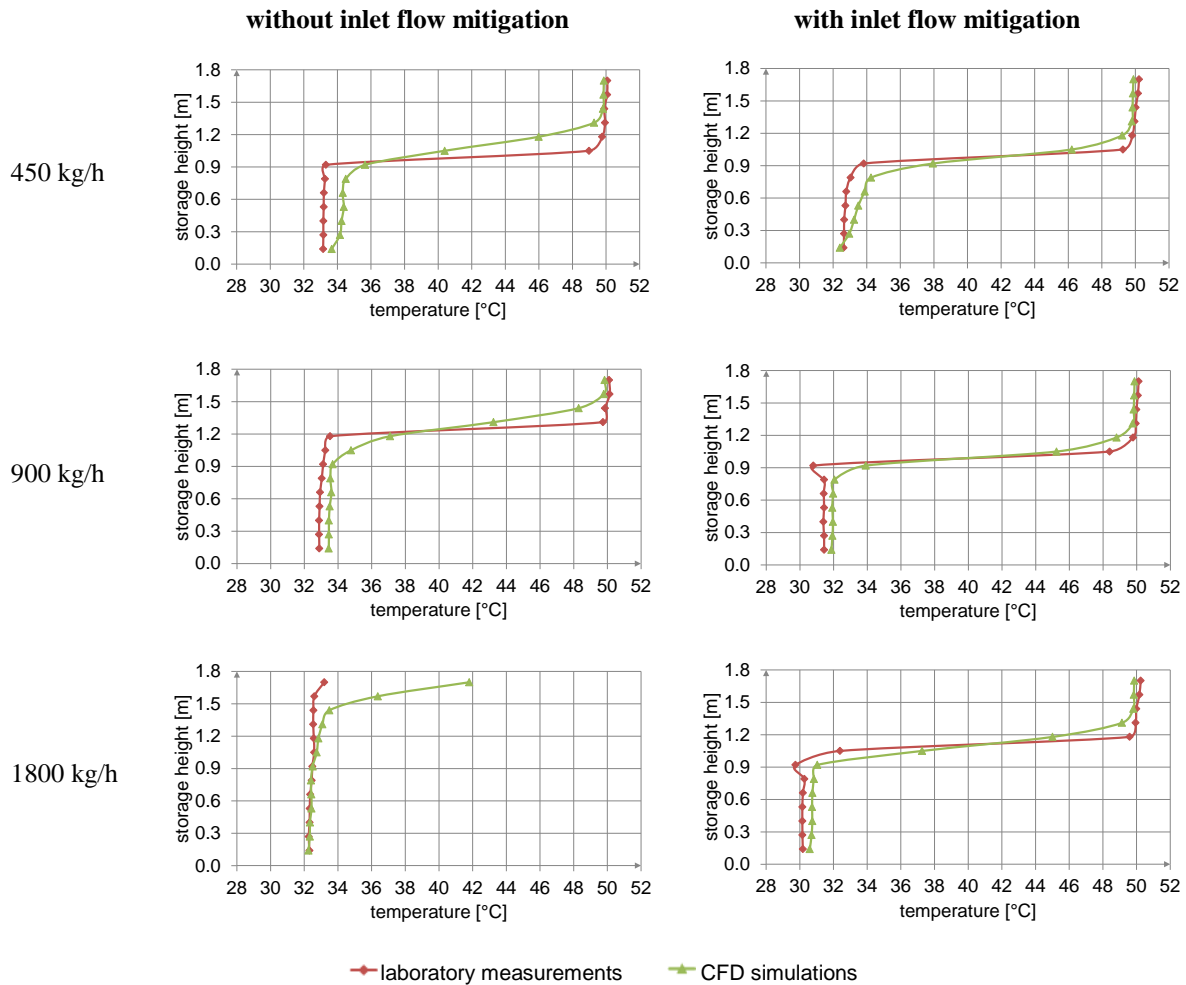

Fig. 9: Inlet flow velocity mitigation plate for inside storage mounting and 90° elbow before the storage inlet

Neither simulations nor measurements showed a significant influence of the 90° elbow on the disturbance of the 50 °C zone of the storage tank. However, the influence of the flow velocity mitigation plate was quite pronounced, as can be seen in Fig. 10. The comparison between CFD simulations and laboratory measurements reveals that the simulations predict adequately the speed of propagation of the thermocline towards the top of the storage tank. However, there is a significant difference in the slope of the thermocline, with measurements showing a quite sharper thermocline, i.e. a higher slope in terms of  $dT/dh$  in the thermocline region, than the CFD simulations.



**Fig. 10: Temperature distributions inside the storage after one hour: comparison between laboratory measurements and CFD simulations with and without inlet flow mitigation**

#### 4. Conclusion

CFD simulations for direct storage charging or discharging by inlets at the mid-height of a combi-storage were carried out and showed that the disturbance of the DHW zone above the inlet strongly depends on the mass flow rate and on the geometry of the inlet. A comparison of CFD simulations with laboratory measurements revealed that the simulations are reproducing accurately the speed of propagation of the thermocline towards the top of the storage tank and hence the rate of increase of the mixed volume of the tank. However, the slope of the thermocline remained more pronounced for the measurements than for the results from the CFD simulations. The simulation results show that direct inlets at mid-height of the storage with an inner diameter of as large as 2" do not preserve the homogenous temperature of the DHW zone in the upper part of the storage for mass flow rates of 1800 kg/h. For all simulations and measurements with inlet velocities of 0.1 m/s and lower, the temperature in the upper part of the storage was well preserved as long as the flow velocity mitigation duct is long enough. This finding is in line with the general recommendations given without documented scientific proof by Jenni (2000, p.4), but is quite lower than the values that can be derived from the recommendations given by Carlsson (1993). According to the simulation results, a minimum length is needed for the flow velocity mitigation ducts inside the storage in order to lead to a sufficiently developed velocity profile within the duct. If the velocity profile is not sufficiently developed, locally increased velocities may lead to increased mixing in the storage and disturb its stratification. This phenomena was observed for several of the flow velocity mitigation devices simulated in the first set of simulations, and possibly also for the experiment and simulation of 1800 kg/h mass flow inlet with the channel / plate flow velocity mitigation duct in the second set. Further work is needed in order to confirm the applicability of these findings for larger storages and pipe diameters and in order to find the required minimum length of the mitigation ducts for a sufficiently developed flow profiles



## 5. Acknowledgement

The financial support of the Swiss Federal Office of Energy SFOE within the project StorEx, contract no SI/500935- 01, is gratefully acknowledged.

## 6. References

- Aviv, A., Blyakhman, Y., Beeri, O., Ziskind, G. & Letan, R., 2009. *Experimental and Numerical Study of Mixing in a Hot-Water Storage Tank*. *Journal of Solar Energy Engineering*, 131(1), p.011011–8.
- Van Berkel, J., Rindt, C.C.M. & van Steenhoven, A.A., 2002. *Thermocline dynamics in a thermally stratified store*. *International Journal of Heat and Mass Transfer*, 45(2), p.343–356.
- Carlsson, P.F., 1993. *Heat Storage for Large Low Flow Solar Heating Systems*. In: *Proc. of the ISES Solar World Congress*, Budapest, 5, 441–445.
- Drück, H., 2007. *Mathematische Modellierung und experimentelle Prüfung von Warmwasserspeichern für Solaranlagen*. PhD Thesis, Institut für Thermodynamik und Wärmetechnik (ITW) der Universität Stuttgart, Shaker Verlag, Aachen.
- Haberl, R., Haller, M.Y., Reber, A. & Frank, E., 2014. *Combining Heat Pumps with Combistores: Detailed Measurements Reveal Demand for Optimization*. *Energy Procedia*, 48, p.361–369.
- Haller, M.Y., Haberl, R., Mojic, I. & Frank, E., 2014. *Hydraulic Integration and Control of Heat Pump and Combi-storage: Same Components, Big Differences*. *Energy Procedia*, 48, p.571–580.
- Huggenberger, A., 2013. *Schichtung in thermischen Speichern - Konstruktive Massnahmen am Einlass zum Erhalt der Schichtung*. Bachelor Thesis, Institut für Solartechnik SPF, University of Applied Sciences HSR, Rapperswil, Switzerland.
- Jenni, J., 2000. *Speicher in Theorie und Praxis*. Jenni Energietechnik AG, Oberburg bei Burgdorf.
- Kaufmann, M., 2013. *Optimierung der Wärmeschichtung in Kombiwärmespeicher - Numerische Simulationen von verschiedenen Einströmgeometrien*. SPF Institut für Solartechnik, Hochschule für Technik HSR, Rapperswil, Switzerland.
- Lötscher, L. & Podhradsky, J., 2014. *Analyse der Temperaturschichtung bei direkter Beladung von Kombi-Wärmespeichern*. Bachelor Thesis, Institut für Solartechnik SPF, University of Applied Sciences HSR, Rapperswil, Switzerland.
- Phillips, W.F. & Dave, R.N., 1982. *Effects of Stratification on the Performance of Liquid-Based Solar Heating-Systems*. *Solar Energy*, 29(2), p.111–120.
- Shah, L.J. & Furbo, S., 2003. *Entrance Effects in Solar Storage Tanks*. *Solar Energy*, 75(4), p.337–348.
- Sharp, M.K. & Loehrke, R.I., 1979. *Stratified thermal storage in residential solar energy applications*. *Journal of Energy*, 3, p.106–113.